



Betopres

Patron českých střeš

Návod k montáži

Střešní výlez Betopres 600x600 mm

SVB 60 × 60

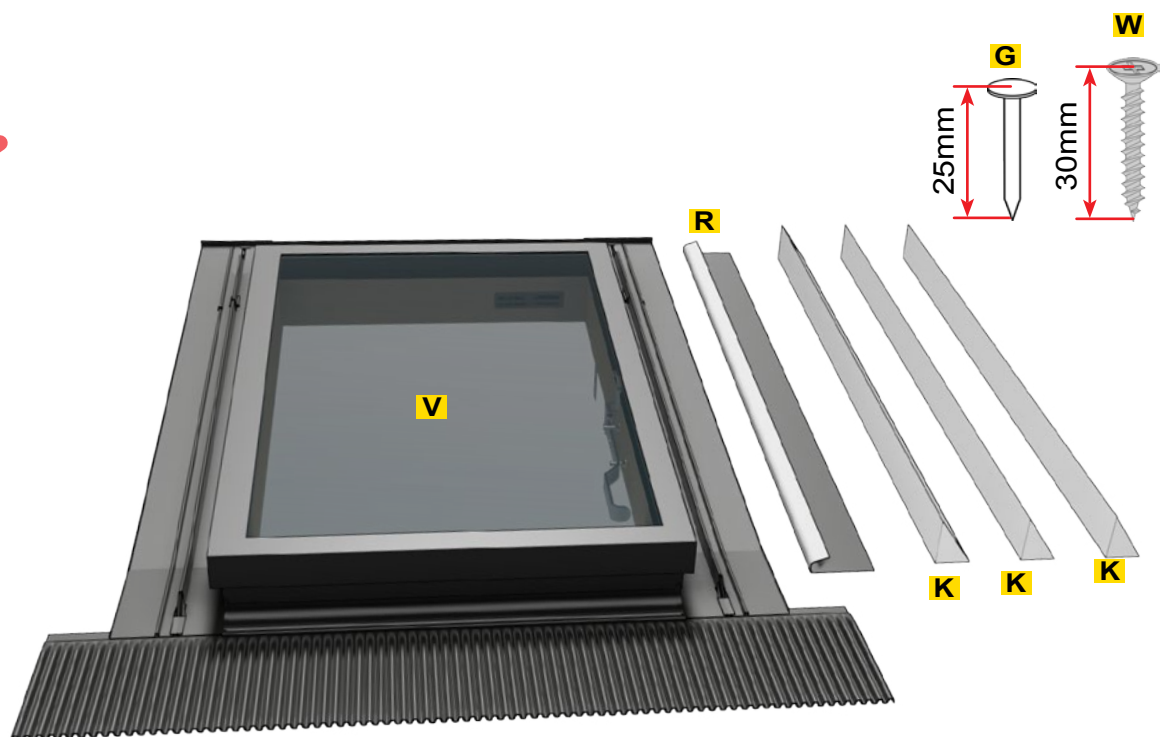
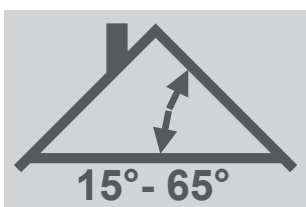
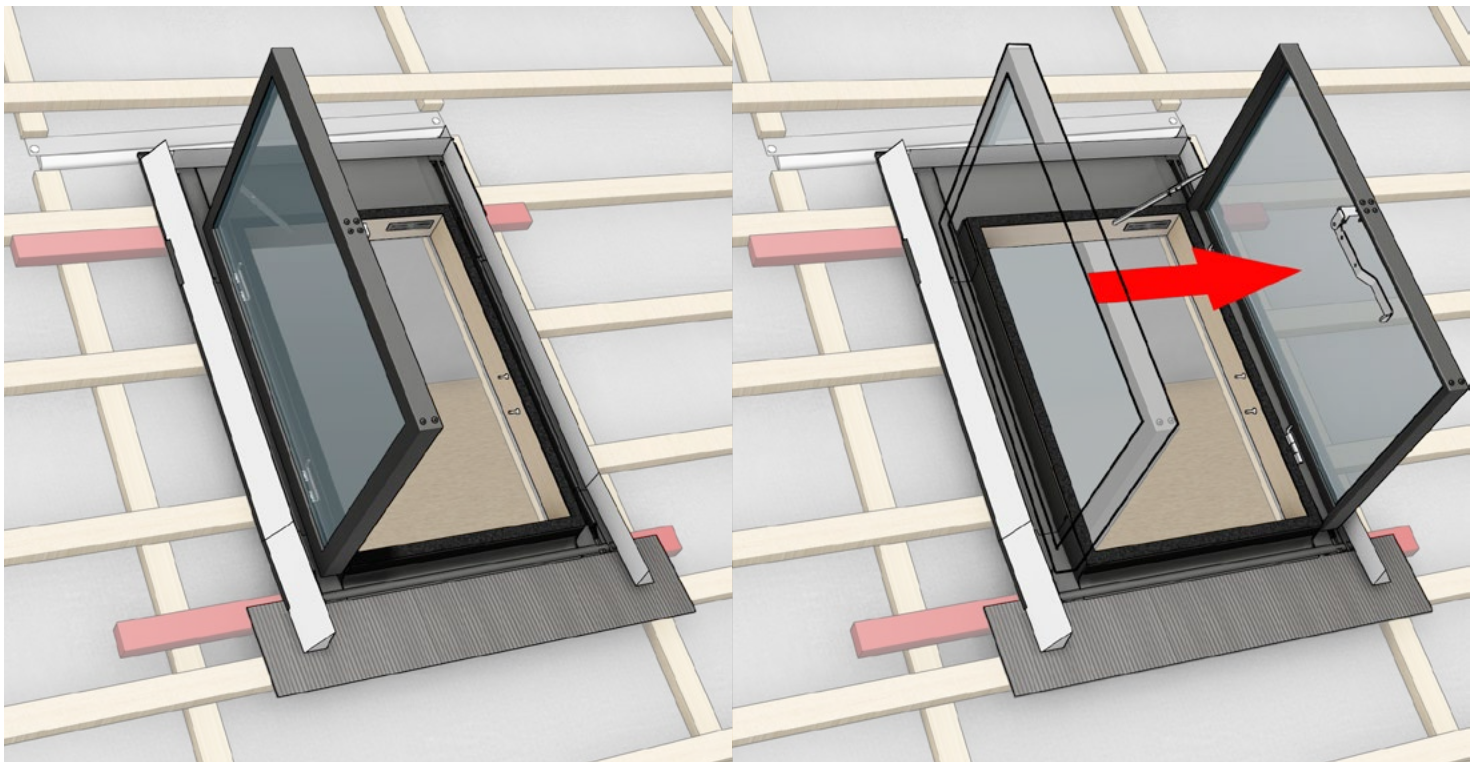

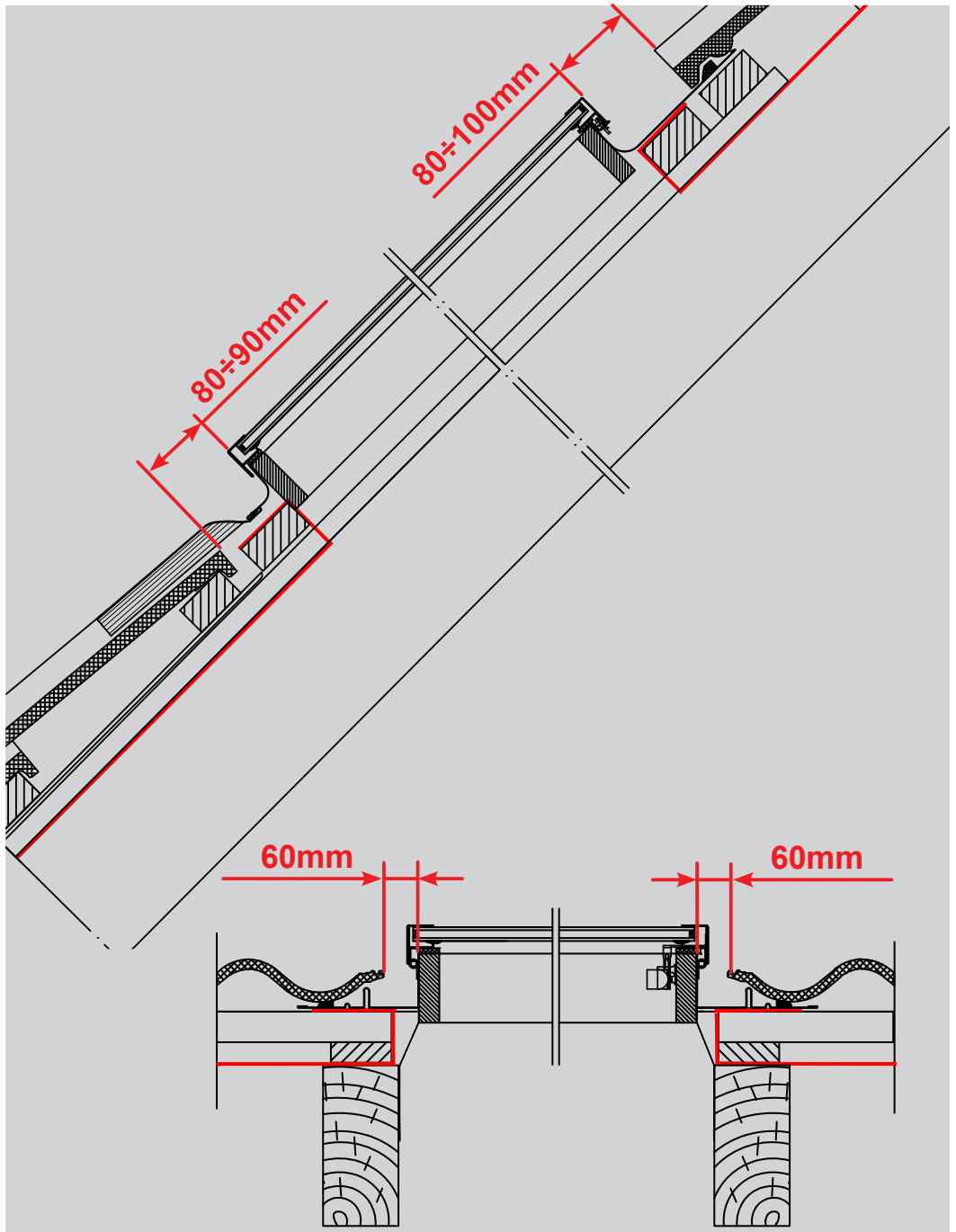
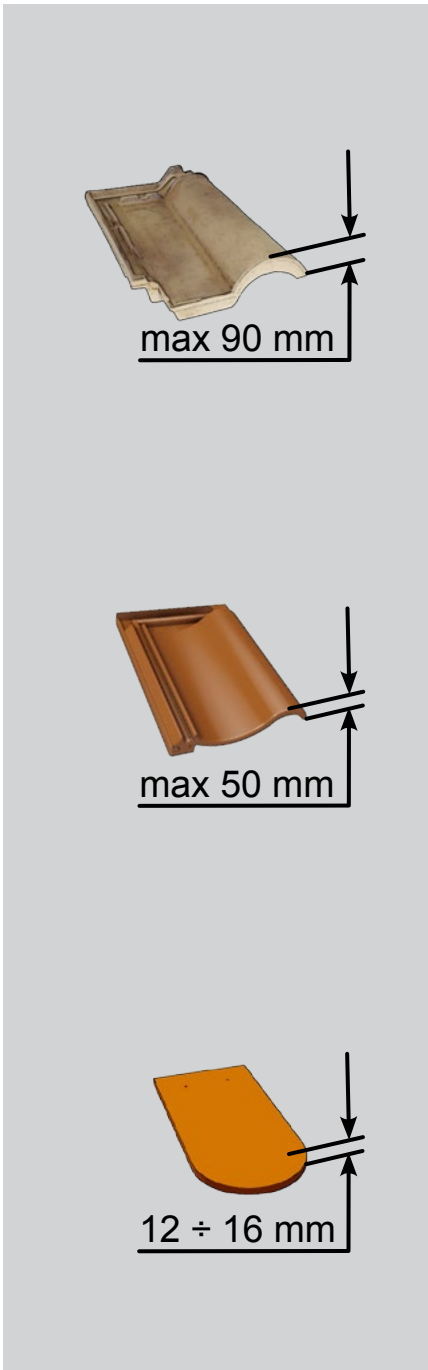
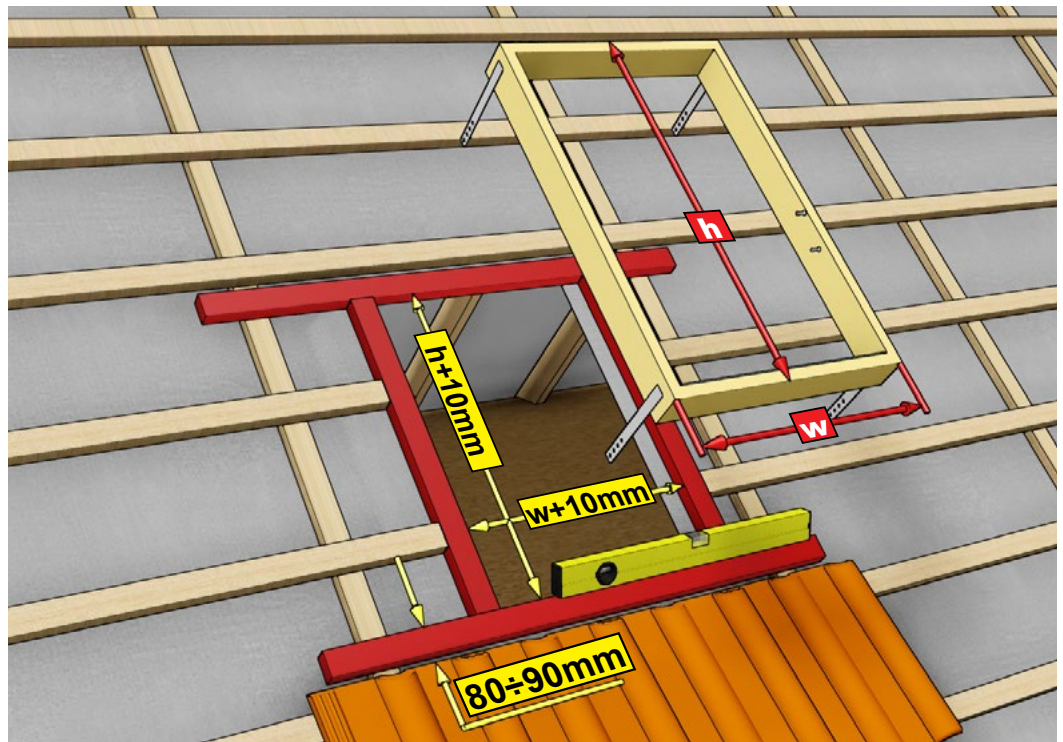
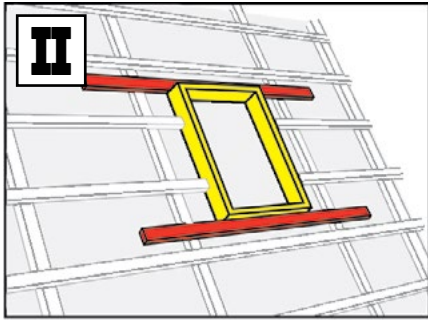
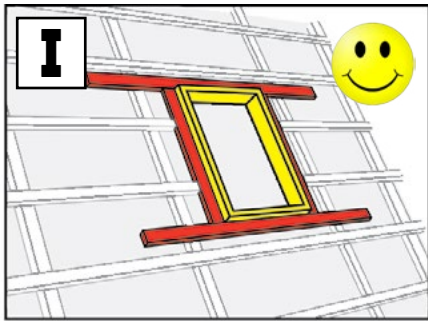

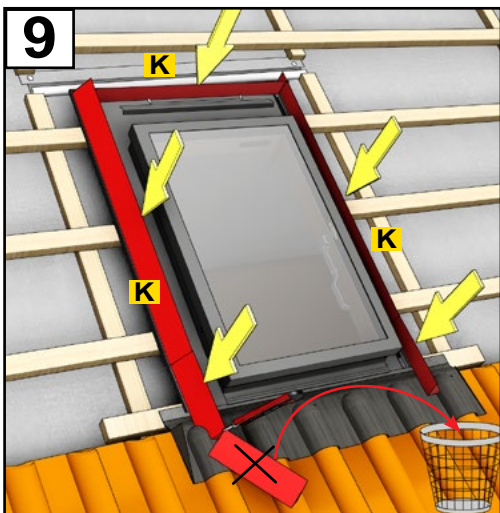
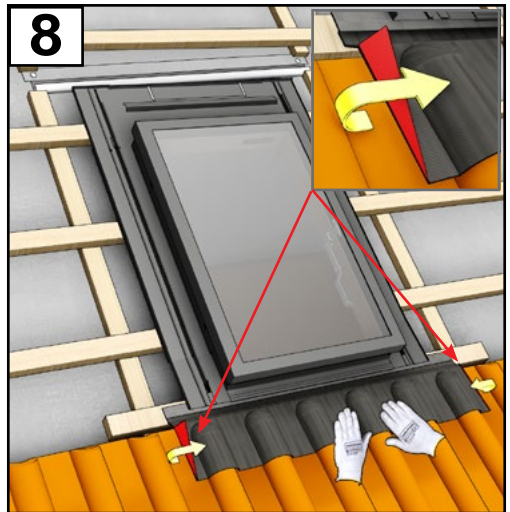
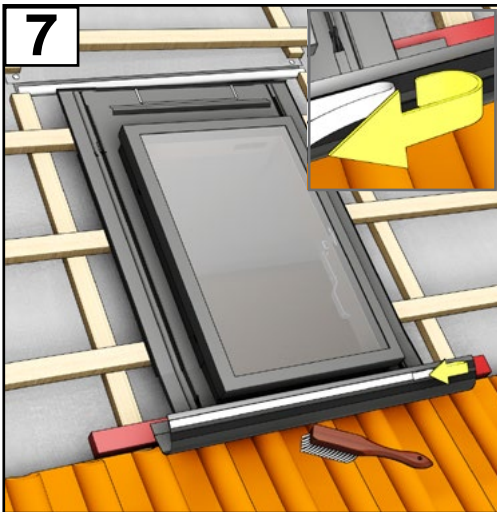
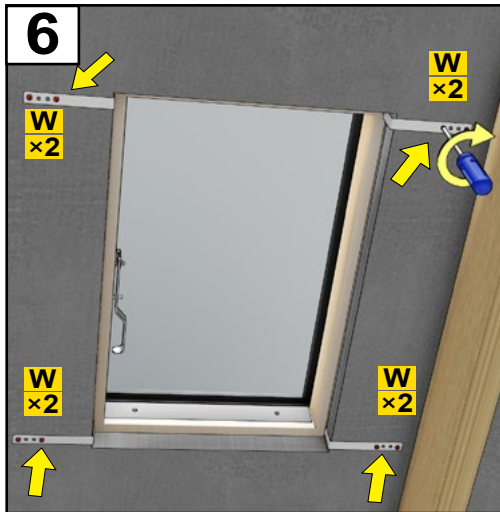
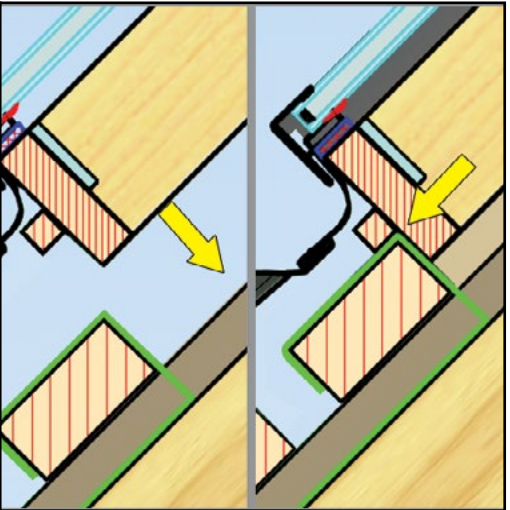
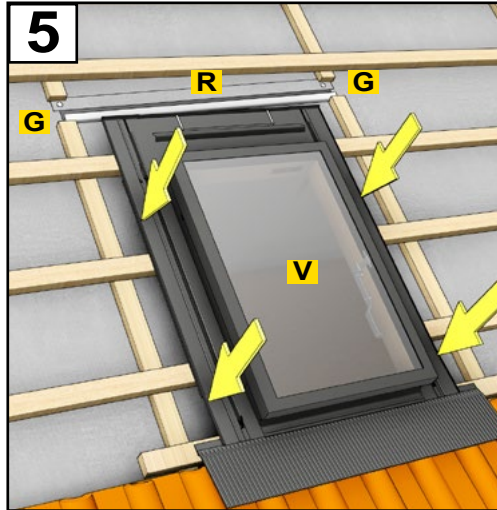
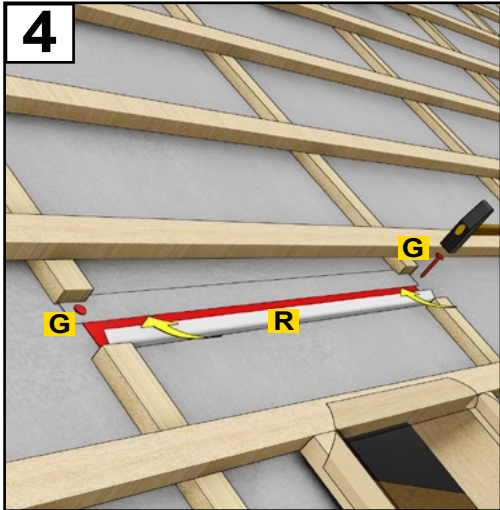
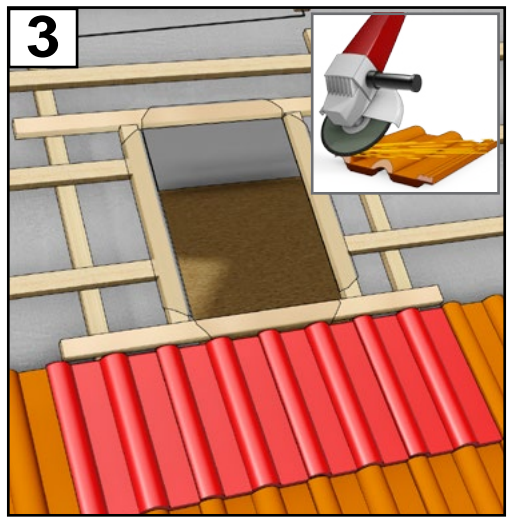
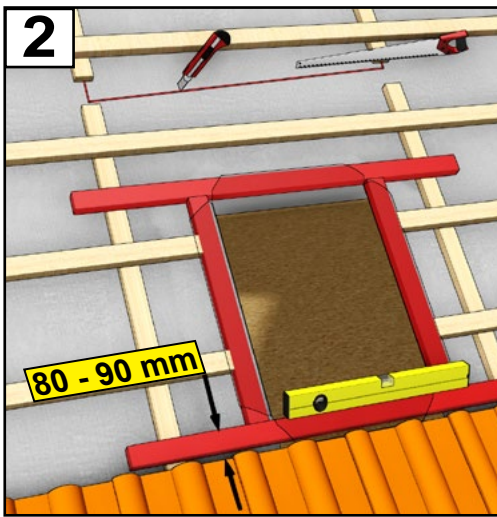
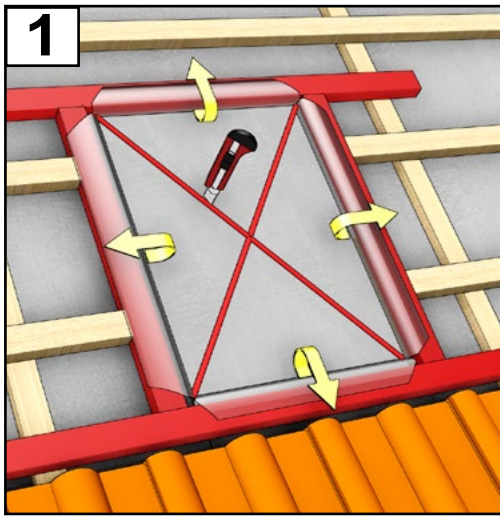

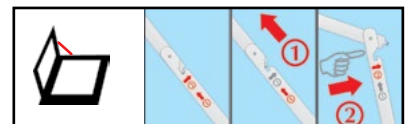
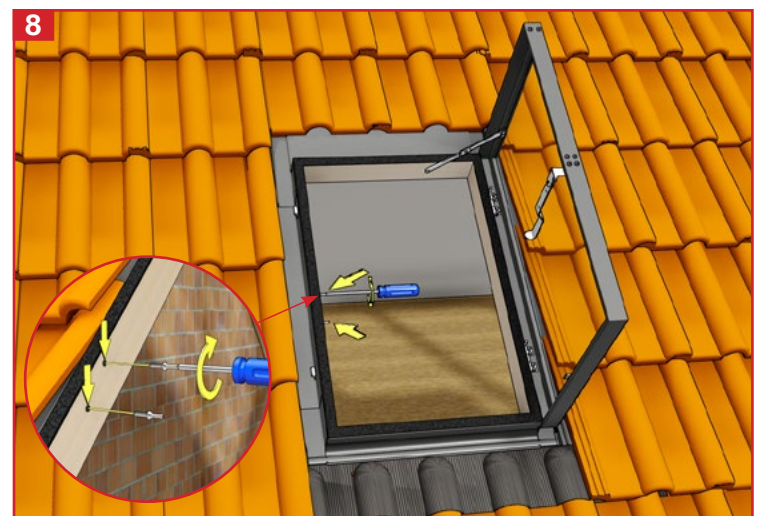
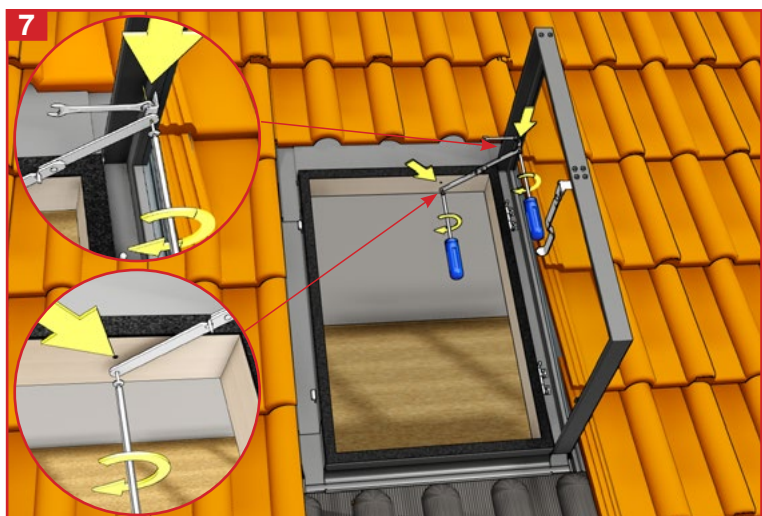
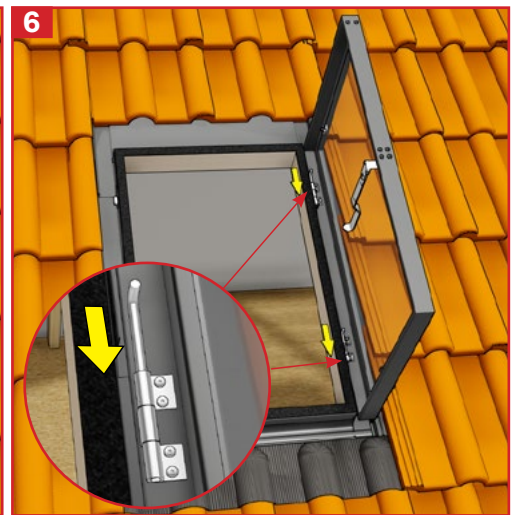
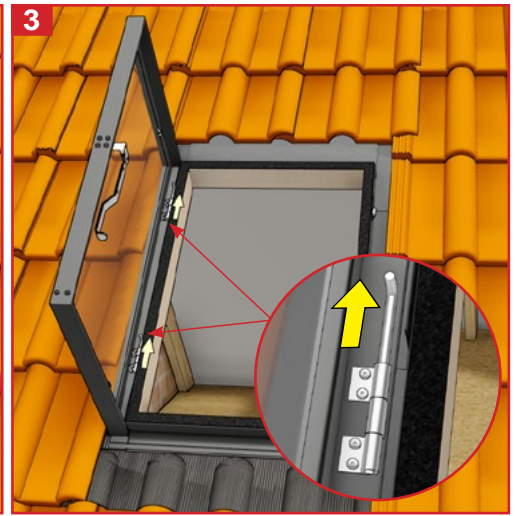
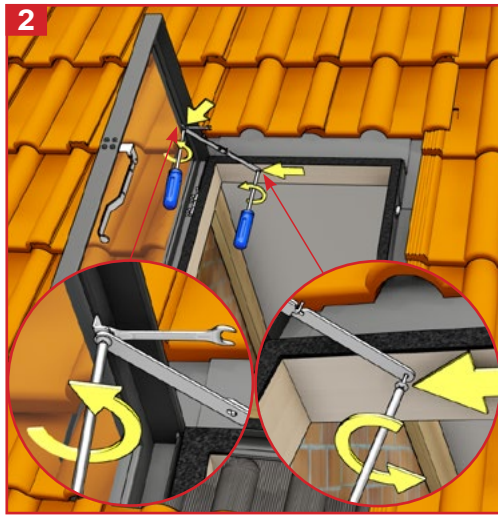
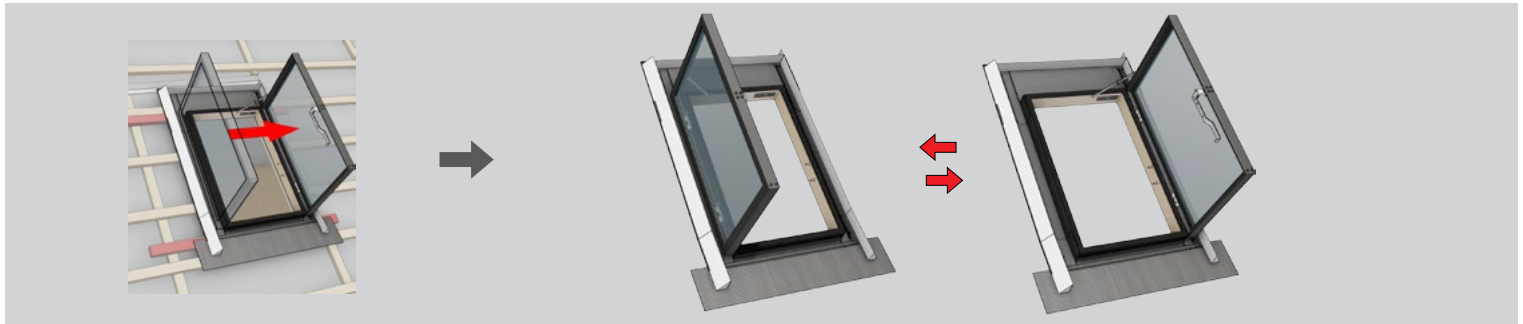

Betonpres a.s.

T: +420 385 724 621
E: info@betonpres.cz

IČO: 60646551
DIČ: CZ60646551

www.betonpres.cz